



# EVL8794-LE-00A

## High Efficiency, 20A, 16V, Synchronous Step-Down Converter Evaluation Board

### DESCRIPTION

The EVL8794-LE-00A is an evaluation board designed to demonstrate the capabilities of the MP8794. The MP8794 is a high-efficiency, monolithic, synchronous step-down converter.

The evaluation board can deliver 20A of continuous load current across a wide operating input range. High efficiency can be achieved across a wide output current load range.

The MP8794 adopts internally compensated constant-on-time (COT) control mode that provides fast transient response and eases loop stabilization.

This evaluation board can be turned on or off via a remote on/off input (EN) that is referenced to ground. This input is compatible with popular logic devices.

### ELECTRICAL SPECIFICATIONS

Parameter	Symbol	Value	Units
Input voltage	$V_{IN}$	8 to 16	V
Output voltage	$V_{OUT}$	1	V
Output current	$I_{OUT}$	20	A

### FEATURES

- Wide Input Voltage Range from 2.7V:
  - 2.7V to 16V with External 3.3V VCC Bias
  - 4V to 16V with Internal VCC Bias or External 3.3V VCC Bias
- Differential Output Voltage Remote Sense
- Programmable Accurate Current Limit Level
- 20A Output Current
- Low  $R_{DS(ON)}$  Integrated Power MOSFETs
- Adaptive COT for Ultra-Fast Transient Response
- Stable with Zero-ESR Output Capacitor
- Excellent Load Regulation
- Output Voltage Tracking
- Output Voltage Discharge
- PGOOD Active Clamped Low Level during Power Failure
- Programmable Soft-Start Time from 1ms
- Pre-Biased Start-Up
- Selectable Switching Frequency: 600kHz, 800kHz, or 1000kHz
- Non-Latch OCP, OVP, UVP, UVLO, Thermal Shutdown
- Output Adjustable from 0.6V to 90% of  $V_{IN}$ , Up to 5.5V Max
- Available in a QFN (3mmx4mm) Package



Optimized Performance with  
MPS Inductor MPL-AY1265 Series

### APPLICATIONS

- FPGAs
- Flat-Panel Televisions and Monitors
- Multi-Functional Printers
- Access Points and Routers
- Optical Modules

All MPS parts are lead-free, halogen-free, and adhere to the RoHS directive. For MPS green status, please visit the MPS website under Quality Assurance. "MPS", the MPS logo, and "Simple, Easy Solutions" are registered trademarks of Monolithic Power Systems, Inc. or its subsidiaries.

**EVL8794-LE-00A EVALUATION BOARD**



(LxWxH) 81.3mmx77.5mmx16mm

Board Number	MPS IC Number	MPS Inductor
EVL8794-LE-00A	MP8794GLE	MPL-AY1265-R47

## QUICK START GUIDE

The EVL8794-LE-00A's input voltage ( $V_{IN}$ ) can range from 8V to 16V. The minimum 8V  $V_{IN}$  is limited by the EN signal, which is derived from  $V_{IN}$  through a resistor divider (R4 and R6). Lower  $V_{IN}$  values (as low as 2.7V) can be set by fine-tuning the resistor divider values, or by overdriving EN with an external control signal. To set up and use the evaluation board, follow the steps below:

1. Connect the load terminals to:
  - a. Positive (+): VOUT
  - b. Negative (-): GND
2. Preset the power supply output voltage between 8V and 16V, then turn off the power supply.
3. Connect the power supply output terminals to:
  - a. Positive (+): VIN
  - b. Negative (-): GND
4. Ensure that the power supply has a high enough current limit to supply the power.
5. Turn the power supply on. The board should automatically start up.
6. To use the enable function, apply a digital input to the EN pin. Drive EN above 1.5V to turn the regulator on; drive EN below 1V to turn it off.
7. Use R1 and R2 to set  $V_{OUT}$  with  $V_{FB} = 0.6V$ . Refer to the MP8794 datasheet to select the proper values for R1, R2, the inductor, and the output capacitor values when  $V_{OUT}$  is changed.
8. Use the jumper (JP1) to select the operating frequency (600kHz, 800kHz, or 1000kHz).

# EVALUATION BOARD SCHEMATIC

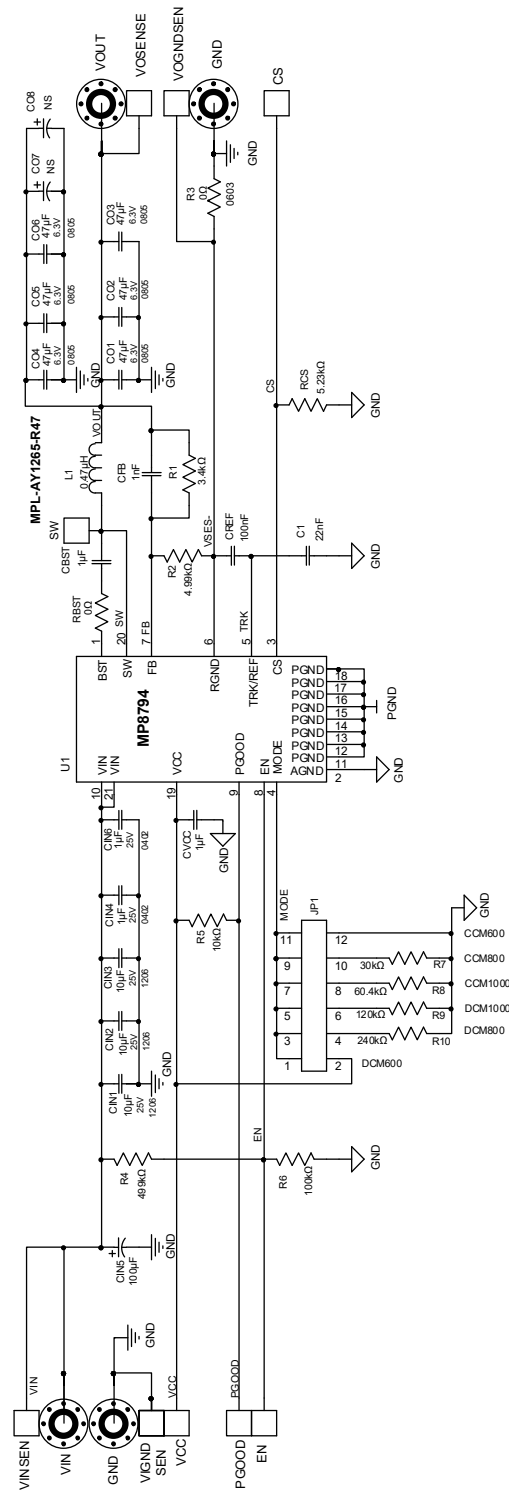

Figure 1: Evaluation Board Schematic

**EVL8794-LE-00A BILL OF MATERIALS**

Qty	Ref	Value	Description	Package	Manufacturer	Manufacturer PN
1	C1	22nF	Ceramic capacitor, 25V, X7R	0603	Wurth	885012206067
2	CBST, CVCC	1 $\mu$ F	Ceramic capacitor, 16V, X7R	0603	Wurth	885012206052
1	CFB	1nF	Ceramic capacitor, 50V, X7R	0603	Wurth	885012206083
3	CIN1, CIN2, CIN3	10 $\mu$ F	Ceramic capacitor, 25V, X5R	1206	Murata	GRM188R61E106MA73L
2	CIN4, CIN6	1 $\mu$ F	Ceramic capacitor, 25V, X5R	0402	Murata	GRM155R61E105KA12D
1	CIN5	100 $\mu$ F	Electrolytic capacitor, 25V, $\pm$ 20%	DIP	Nippon Chemi-Con	EMZJ350ARA101MHA0G
6	CO1, CO2, CO3, CO4, CO5, CO6	47 $\mu$ F	Ceramic capacitor, 6.3V, X5R	0805	Wurth	885012107006
0	CO7, CO8	NS				
1	CREF	100nF	Ceramic capacitor, 25V, X7R	0603	Wurth	885012206071
1	R1	3.4k $\Omega$	Film resistor, 1%,	0603	Yageo	RC0603FR-073K4L
1	R2	4.99k $\Omega$	Film resistor, 1%,	0603	Yageo	RC0603FR-074K99L
2	R3, RBST	0 $\Omega$	Film resistor, 1%	0603	Yageo	RC0603FR-070RL
1	R4	499k $\Omega$	Film resistor, 1%	0603	Yageo	RC0603FR-07499KL
1	R5	10k $\Omega$	Film resistor, 1%	0603	Yageo	RC0603FR-0710KL
1	R6	100k $\Omega$	Film resistor, 1%	0603	Yageo	RC0603FR-07100KL
1	R7	30k $\Omega$	Film resistor, 1%	0603	Yageo	RC0603FR-0730KL
1	R8	60.4k $\Omega$	Film resistor, 1%,	0603	Yageo	RC0603FR-0760K4L
1	R9	120k $\Omega$	Film resistor, 1%	0603	Yageo	RC0603FR-07120KL
1	R10	240k $\Omega$	Film resistor, 1%	0603	Yageo	RC0603FR-07240KL
1	RCS	5.23k $\Omega$	Film resistor, 1%,	0603	Yageo	RC0603FR-075K23L
1	L1	0.47 $\mu$ H	Inductor, DCR = 0.89m $\Omega$ , I <sub>SAT</sub> = 64A	13.5mmx 12.6mm	MPS	MPL-AY1265-R47
1	U1	MP8794	16V, 20A, step-down converter	QFN-21 (3mmx 4mm)	MPS	MP8794GLE

## EVB TEST RESULTS

Performance waveforms are tested on the EVL8794-LE-00A evaluation board.  $V_{IN} = 12V$ ,  $V_{OUT} = 1V$ ,  $f_{SW} = 800kHz$ ,  $T_A = 25^{\circ}C$ , unless otherwise noted.

### Efficiency

PSM, 0.47 $\mu$ H, 800kHz

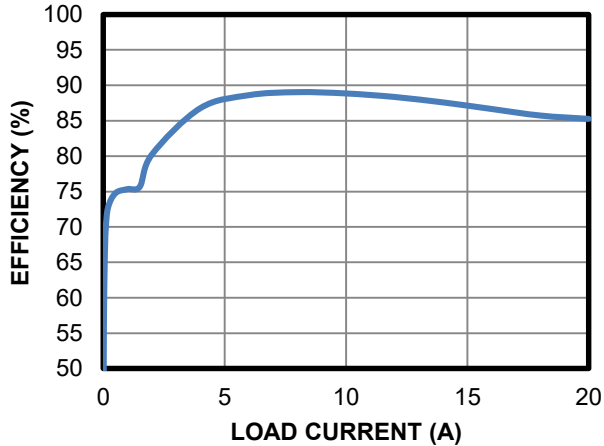

### Efficiency

FCCM, 0.47 $\mu$ H, 800kHz

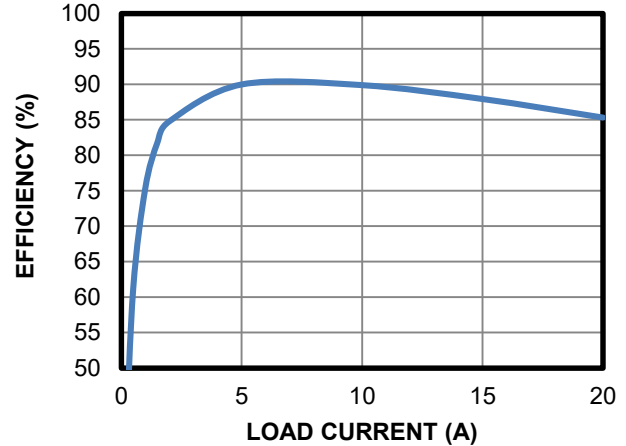

### Thermal Results

800kHz, no air flow

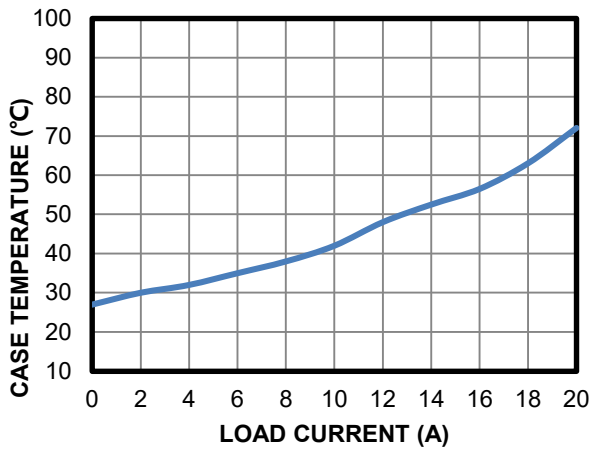

### Switching Frequency vs. Output Current

FCCM

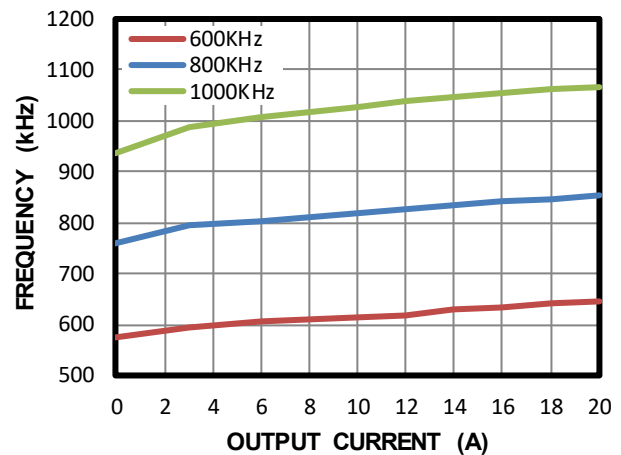

### Output Voltage Load Regulation

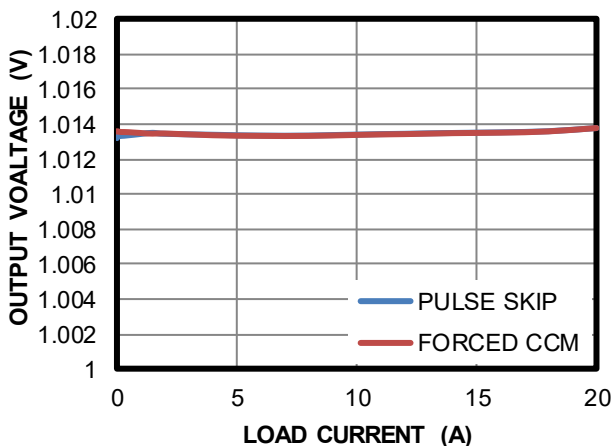

### EVB TEST RESULTS *(continued)*

Performance waveforms are tested on the EVL8794-LE-00A evaluation board.  $V_{IN} = 12V$ ,  $V_{OUT} = 1V$ ,  $f_{SW} = 800kHz$ ,  $T_A = 25^{\circ}C$ , unless otherwise noted.

#### Steady State

$I_{OUT} = 0A$ , PSM

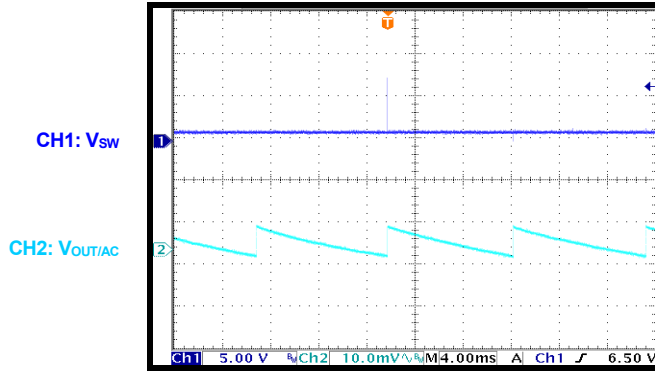

#### Steady State

$I_{OUT} = 0.5A$ , PSM

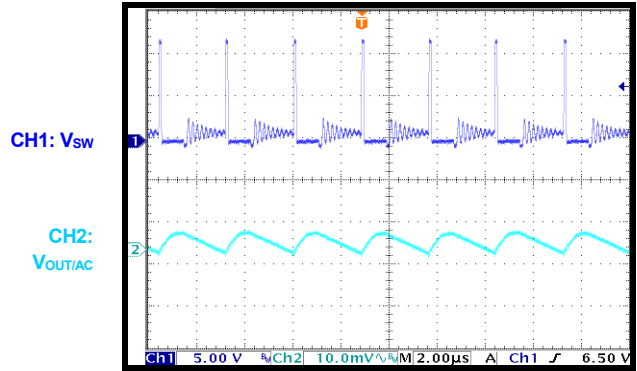

#### Steady State

$I_{OUT} = 20A$ , PSM

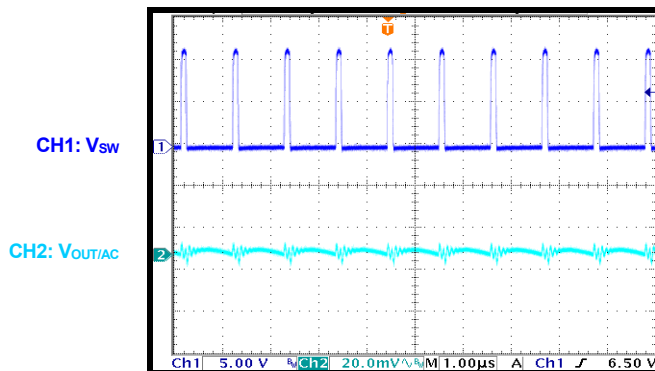

#### Steady State

$I_{OUT} = 0A$ , FCCM

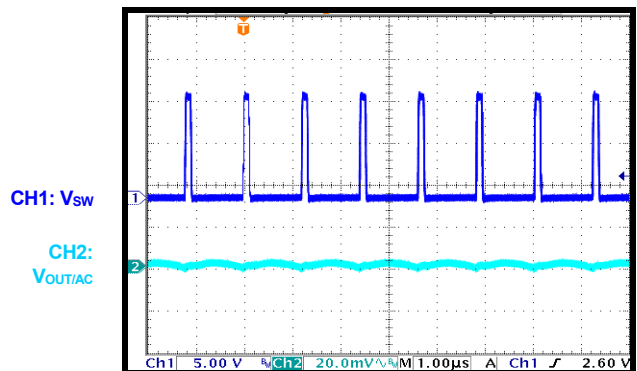

#### Steady State

$I_{OUT} = 20A$ , FCCM

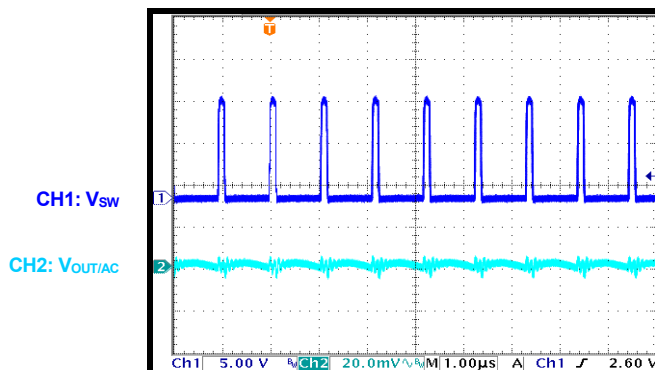

#### Load Transient

$I_{OUT} = 0A$  to  $8A$ , PSM

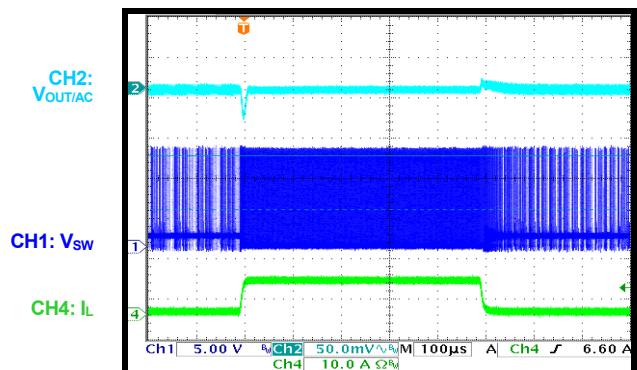

### EVB TEST RESULTS (continued)

Performance waveforms are tested on the EVL8794-LE-00A evaluation board.  $V_{IN} = 12V$ ,  $V_{OUT} = 1V$ ,  $f_{SW} = 800kHz$ ,  $T_A = 25^{\circ}C$ , unless otherwise noted.

#### Load Transient

$I_{OUT} = 0A$  to  $8A$ , FCCM

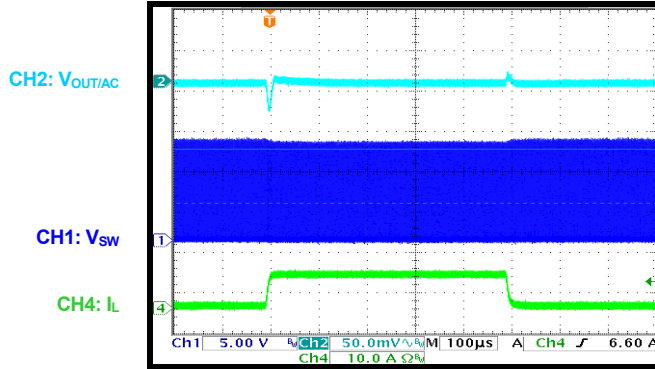

#### Start-Up through EN

$I_{OUT} = 0A$ , PSM

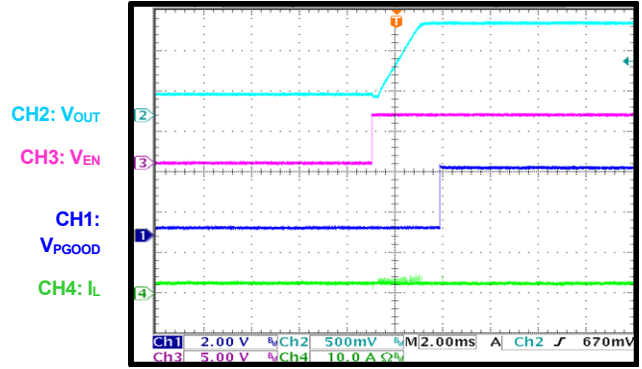

#### Start-Up through EN

$I_{OUT} = 0A$ , FCCM

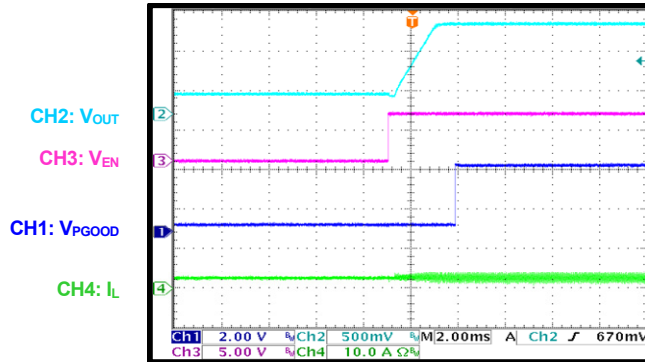

#### Start-Up through EN

$I_{OUT} = 20A$

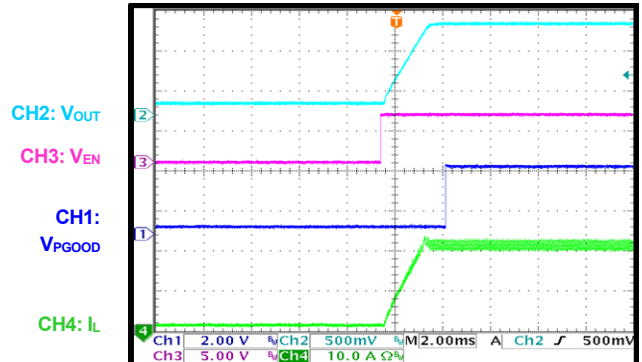

#### Shutdown through EN

$I_{OUT} = 0A$ , PSM

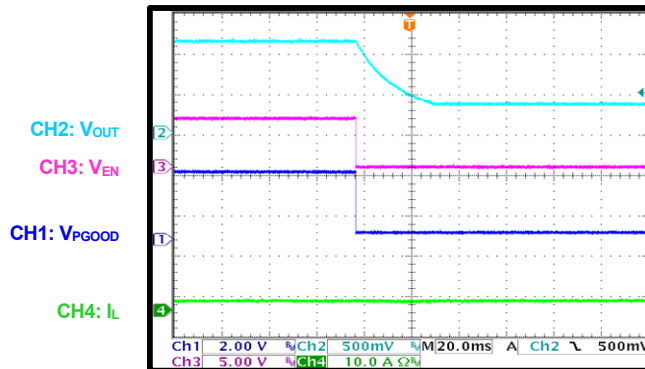

#### Shutdown through EN

$I_{OUT} = 0A$ , FCCM

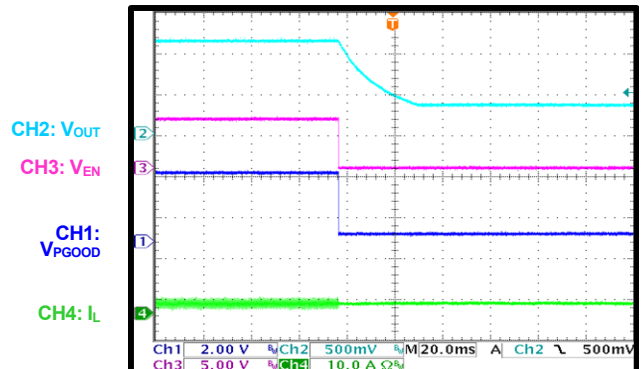



### EVB TEST RESULTS (continued)

Performance waveforms are tested on the EVL8794-LE-00A evaluation board.  $V_{IN} = 12V$ ,  $V_{OUT} = 1V$ ,  $f_{SW} = 800kHz$ ,  $T_A = 25^{\circ}C$ , unless otherwise noted.

#### Shutdown through EN

$I_{OUT} = 20A$

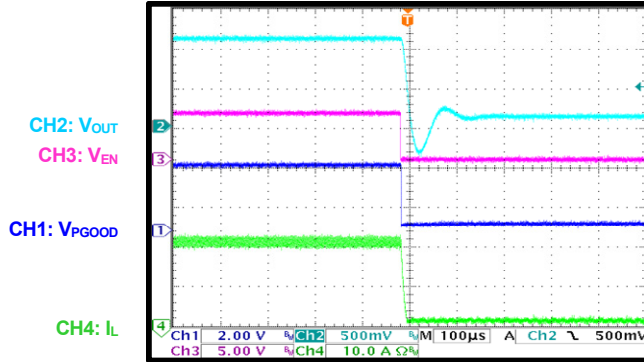

#### Pre-Biased Start-Up

PSM

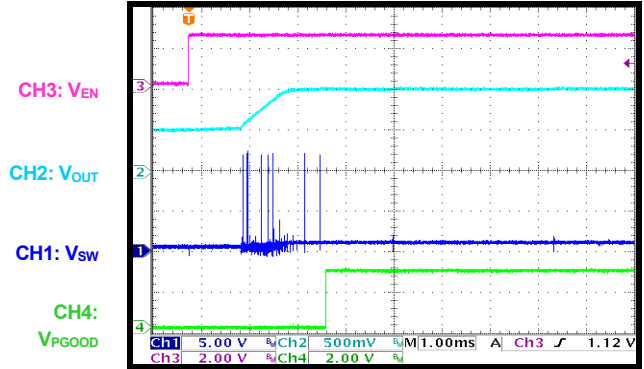

#### Pre-Biased Start-Up

FCCM

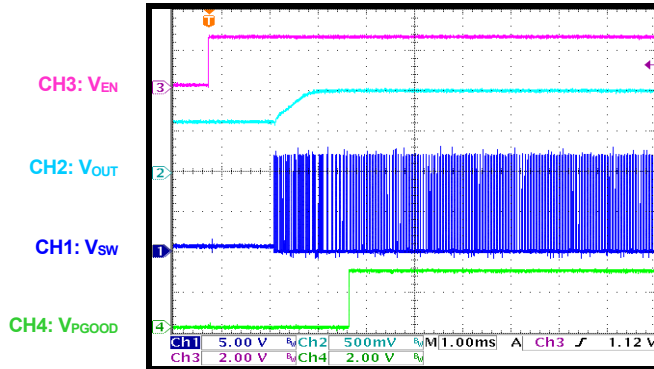

#### Over-Current Protection Entry

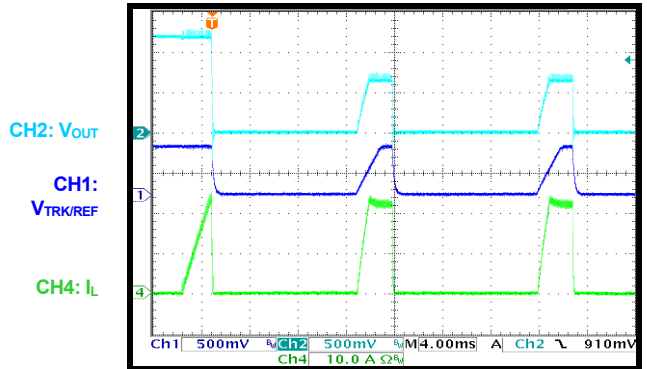

#### Over-Current Protection Recovery

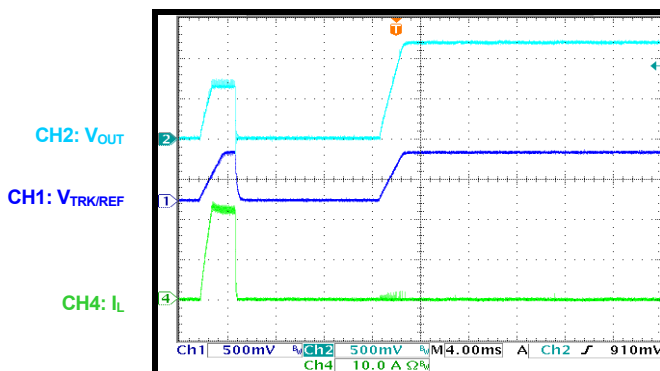

### PCB LAYOUT

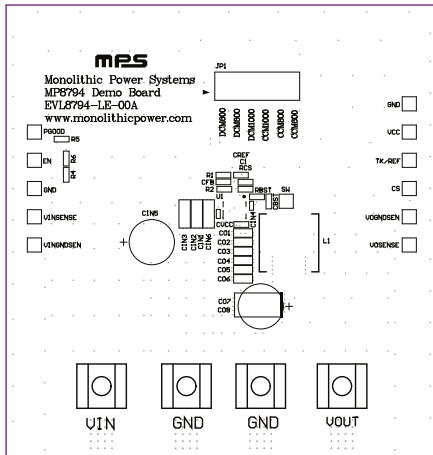

Figure 2: Top Silk

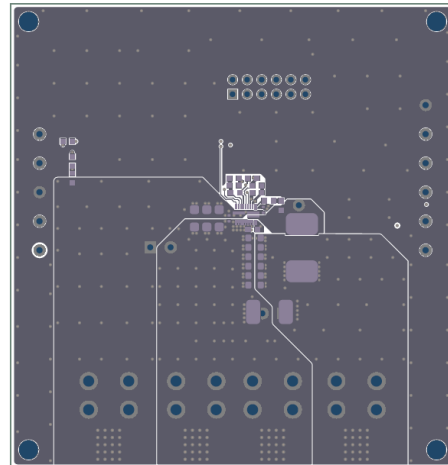

Figure 3: Top Layer

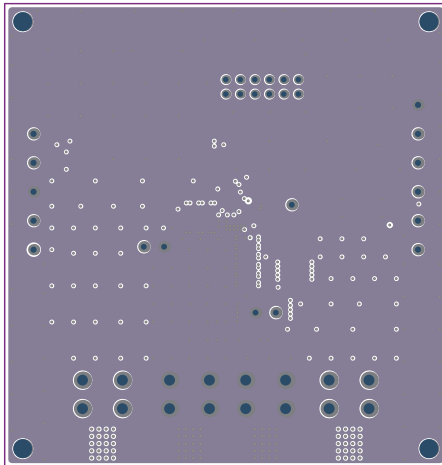

Figure 4: Mid-Layer 1

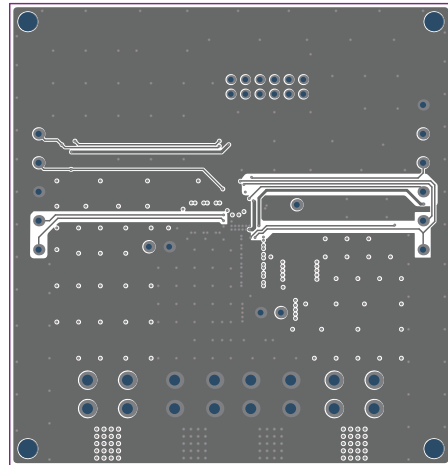

Figure 5: Mid-Layer 2

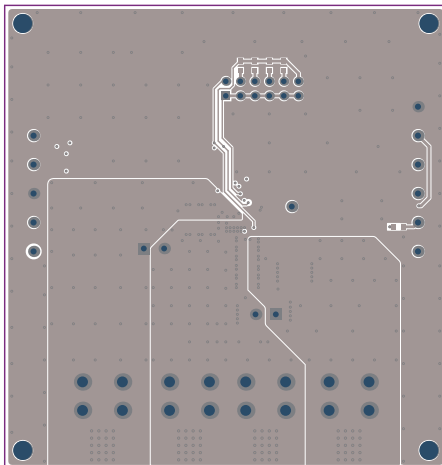

Figure 6: Bottom Layer

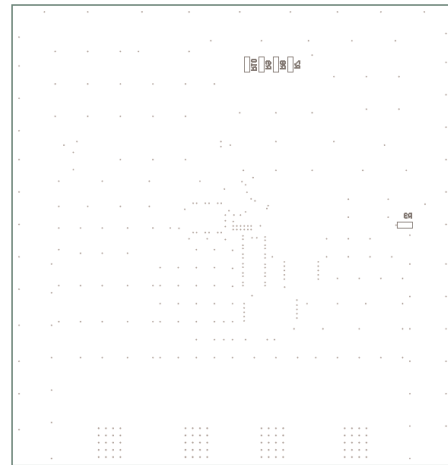

Figure 7: Bottom Silk



## REVISION HISTORY

Revision #	Revision Date	Description	Pages Updated
1.0	07/27/2021	Initial Release	-

**Notice:** The information in this document is subject to change without notice. Please contact MPS for current specifications. Users should warrant and guarantee that third-party Intellectual Property rights are not infringed upon when integrating MPS products into any application. MPS will not assume any legal responsibility for any said applications.